



G7 Hinge

Bi-stable

- Automatically drives to one of two preferred positions
- Invisible when installed

Material and Finish

Acetal black, steel, zinc plated

Performance Details

Cycle performance: 20,000 cycles within $\pm 20\%$ of normal torque specification

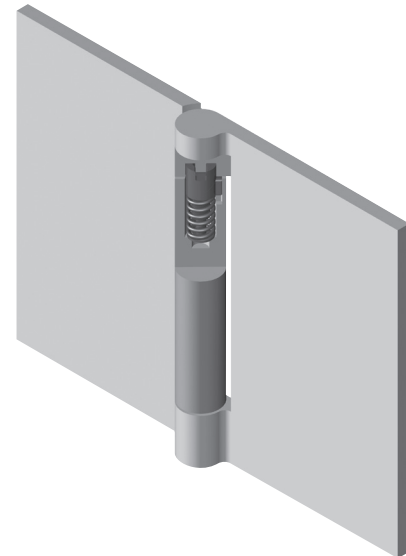
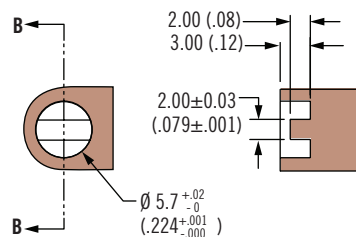
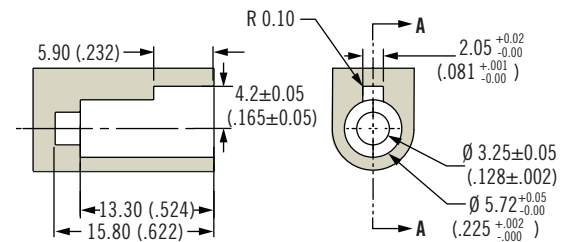
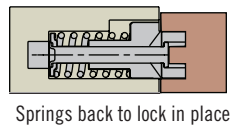
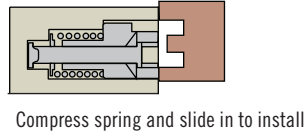
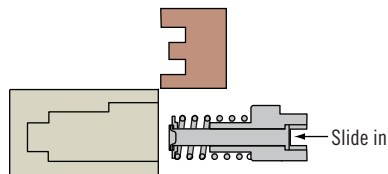
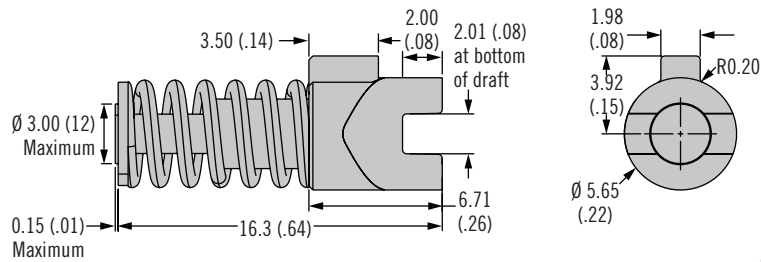

Part Number

See table

Part Number	Maximum Torque N·m (in·lbf)
G7-6A-3P-1	0.035 (.3)