



SOUTHCO No. 38 DRIVE RIVETS - ALUMINUM
1/4 DIA. UNIVERSAL HEAD

DATE	DRAWN	CHKD	SCALE	DRAWING NUMBER
12-28-89	JSS		N.T.S.	J-38-108-16 A

REV. LET.	DATE	BY	CHKD.	REVISIONS
A	9-11-91	GWP		PRN: 38-163
B	4-20-92	JCK		PRN: 38-166
C	5 MAR 93	JC		PAN: S-1-03
D	27 MAR 96	AJH		PRN: 10-21
E	20 NOV 97	PJK	KCW	PRN: 38-249
F	12 APR 2021	CMS/CTG		PRM: P2021-0609

RIVET MATERIAL & FINISH				ALUMINUM-NATURAL	
PIN MATERIAL & FINISH				ALUMINUM NATURAL	
NOMINAL GRIP	ACTUAL GRIP		"L"	ASSEMBLED RIVET PART NO	
	MIN.	MAX.			
1/16	.047	.140	1/4	.02-16	
1/8	.078	.171	3/32	04	
3/16	.140	.234	1/2	06	
1/4	.203	.296	13/32	08	
5/16	.265	.359	15/32	10	
3/8	.328	.421	17/32	12	
7/16	.390	.484	19/32	14	
1/2	.453	.546	21/32	16	
9/16	.515	.609	23/32	18	
5/8	.578	.671	25/32	20	
11/16	.640	.734	27/32	22	
3/4	.703	.796	29/32	24	
13/16	.765	.859	31/32	26	
7/8	.828	.921	1 1/32	28	
15/16	.890	.984	1 2/32	30	
1	.953	1.046	1 4/32	32	
1 1/16	1.015	1.109	1 6/32	34	
1 1/8	1.078	1.171	1 8/32	36	
1 3/16	1.140	1.234	1 10/32	38	
1 1/4	1.203	1.296	1 12/32	40	
1 1/2	1.265	1.359	1 14/32	41	
1 5/8	1.328	1.421	1 16/32	42	
1 3/4	1.390	1.484	1 18/32	38-108-43-16	

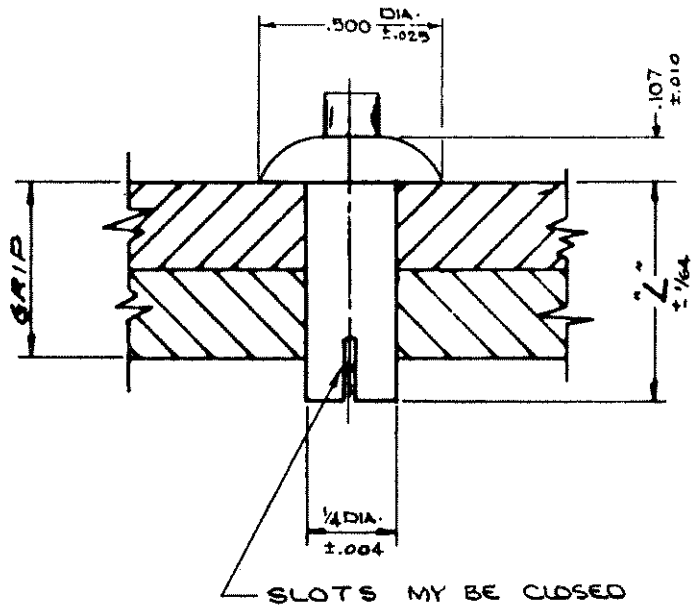

PROPRIETARY ITEM - EXCEPT FOR USES EXPRESSLY GRANTED IN WRITING, INFORMATION DISCLOSED HEREON IS CONFIDENTIAL AND ALL RIGHTS, PATENT AND OTHERWISE, ARE RESERVED BY SOUTHCO, INC.

DRAWING NUMBER
J-38-108-16 A